



**Kimtech**

C O M M U N I C A T I O N S

**Dome Heat Shrinkable Seal Fiber Optic Splice Closure  
(FOSC)**

**B1-OPSP12D**



**Installation Manual**

## 1. Scope of application

This Installation Manual suits for the Fiber Optic Splice Closure (Hereafter abbreviated as FOSC), as the guidance of proper installation.

The scope of application is: aerial, underground, wall-mounting, duct-mounting and handhole-mounting. The ambient temperature ranges from  $-40^{\circ}\text{C}$  to  $+65^{\circ}\text{C}$ .

## 2. Basic structure and configuration

### 2.1 Dimension and capacity

Outside dimension (Height x Diameter)	435mm×190mm
Weight (excluding outside box)	2350 g— 2600g
Number of inlet/out ports	5 pieces in general
Diameter of fiber cable	Φ8mm~Φ25 mm
Capacity of FOSC	Bunchy: 12-96 (cores), Ribbon: up to 288 (cores)

### 2.2 Main components

No.	Name of components	Quantity	Usage	Remarks
1	FOSC cover	1 piece	Protecting fiber cable splices in whole	Height x Diameter 355mm x 150mm
2	Fiber optic splice tray (FOST)	Max. 6 trays (bunchy) Max. 4 trays (ribbon)	Fixing heat shrinkable protective sleeve and holding fibers	Suitable for: Bunchy:12,24(cores) Ribbon:6 (pieces)
3	Fiber holding tray	1 pcs	Holding fibers with protective coat	
4	Base	1set	Fixing internal and external structure	
5	Plastic hoop	1 set	Fixing between FOSC cover and base	
6	Seal fitting	1 piece	Sealing between FOSC cover and base	
7	Pressure testing valve	1 set	After inject air, it is used for pressure testing and sealing testing	Configuration as per requirement

8	Earthing deriving device	1 set	Deriving metal parts of fiber cables in FOSC for earthing connection	Configuration as per requirement
---	--------------------------	-------	--	----------------------------------

### 2.3 Main accessories and special tools

No.	Name of accessories	Quantity	Usage	Remarks
1	Heat shrinkable protective sleeve		Protecting fiber splices	Configuration as per capacity
2	Nylon tie		Fixing fiber with protective coat	Configuration as per capacity
3	Heat shrinkable fixing sleeve (single)		Fixing and sealing single fiber cable	Configuration as per requirement
4	Heat shrinkable fixing sleeve (mass)		Fixing and sealing mass of fiber cable	Configuration as per requirement
5	Branching clip		Branching fiber cables	Configuration as per requirement
6	Earthing wire	1 piece	Putting through between earthing devices	
7	Desiccant	1 bag	Put into FOSC before sealing for desiccating air	
8	Labeling paper	1 piece	Labeling fibers	
9	Special wrench	1 piece	Tightening nut of reinforced core	
10	Metal hoop	1 set	For wall mounting and pole hugging	
11	Buffer tube	decided by customers	Hitched to fibers and fixed with FOST, managing buffer.	Configuration as per requirement
12	Aluminum-foil paper	1 piece	Protect the bottom of FOSC	

### 3. Necessary tools for installation

#### 3.1 Supplementary materials (to be provided by operator)

Name of materials	Usage
Scotch tape	Labeling, temporarily fixing
Ethyl alcohol	Cleaning
Gauze	Cleaning

### 3.2 Special tools (to be provided by operator)

Name of tools	Usage
Fiber cutter	Cutting off fiber cable
Fiber stripper	Strip off protective coat of fiber cable
Combo tools	Assembling FOSC

### 3.3 Universal tools(to be provided by operator)

Name of tools	Usage and specification
Band tape	Measuring fiber cable
Pipe cutter	Cutting fiber cable
Electrical cutter	Take off protective coat of fiber cable
Combination pliers	Cutting off reinforced core
Screwdriver	Crossing/Paralleling screwdriver
Scissor	
Waterproof cover	Waterproof, dustproof
Metal wrench	Tightening nut of reinforced core

### 3.4 Splicing and testing instruments (to be provided by operator)

Name of instruments	Usage and specification
Fusion Splicing Machine	Fiber splicing
OT DR	Splicing testing
Provisional splicing tools	Provisional testing
Fire sprayer	Sealing heat shrinkable fixing sleeve

Notice: The above-mentioned tools and testing instruments should be provided by the operators themselves.

#### 4. Installation flow chart

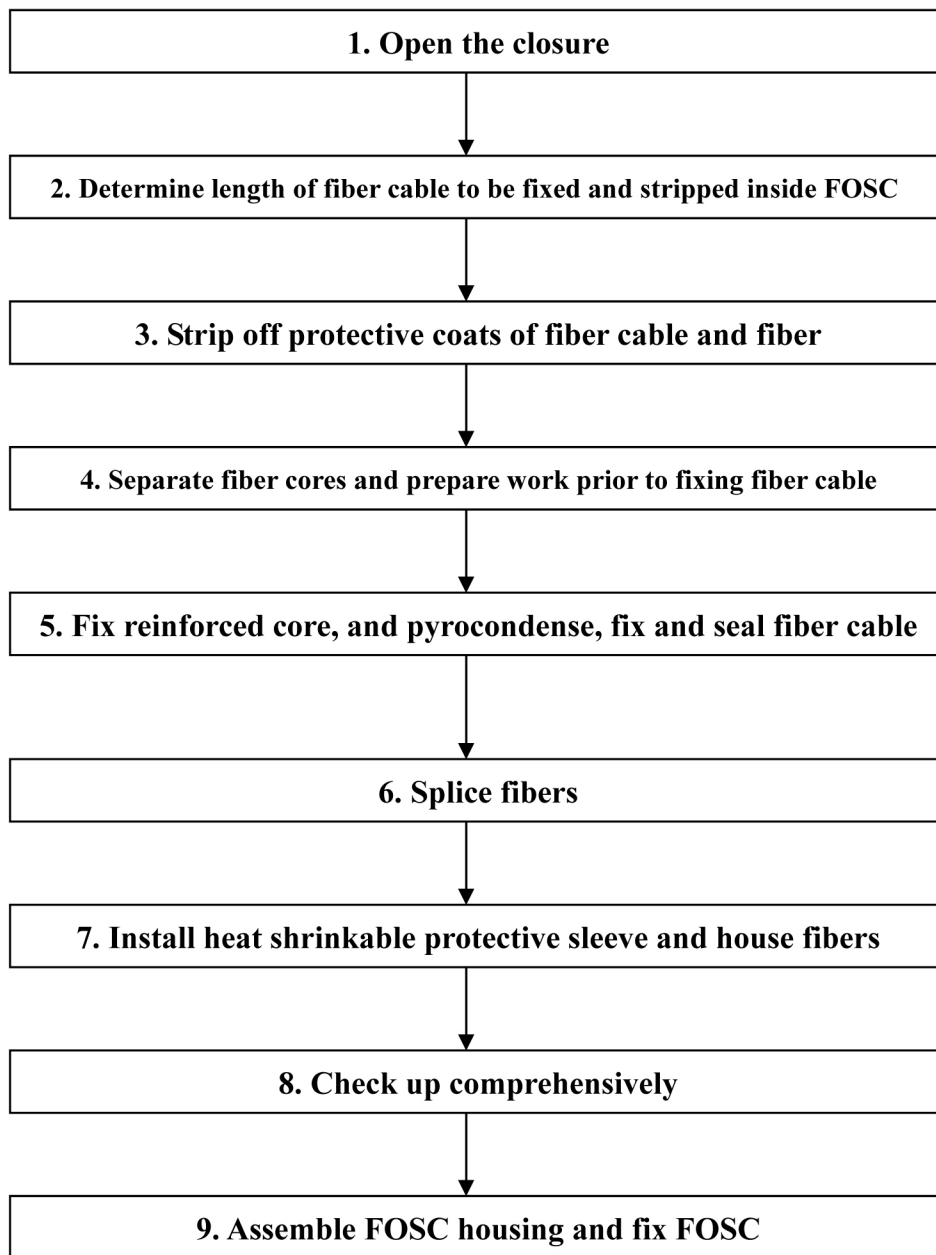

#### 5. The process of installing FOSC.

##### Step One - Open the closure

Cleaning the locale and determine where to install the FOSC and then place fiber cables required.

Check whether the main components and accessories have been well prepared inside the package.

Open the closure

- ① Demount hoop fixing bolt and pull hoop locking system out, then proceed in demounting the hoop.
- ② Pull the FOSC cover upwards out, installation could begin.

See Drawing 1

**Important issues:** If the weather condition is not good enough, then a tent must be pitched for waterproof and dustproof.

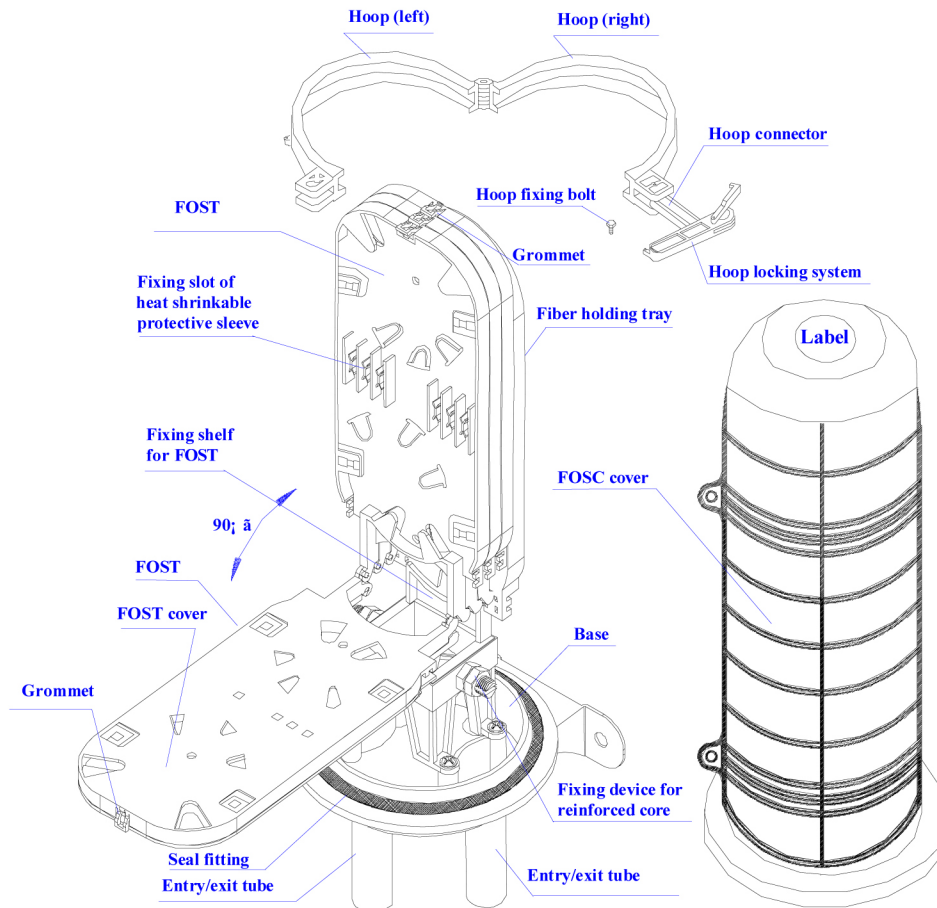

**Drawing 1**

## **Step Two -Determine length of fiber cable to be fixed and stripped inside FOSC**

- 5.2.1 If all fibers are for branch splicing, please refer to Drawing 2(A) for stripping length.
- 5.2.2 If some fibers are for straight-through, while others are for branch splicing, please refer to Drawing 2(B) for stripping length.
- 5.2.3 See Drawing 2.

**Important issues:**

1. Reserve enough length of fiber cable to be spliced.
2. Stripping length also could be decided by customers according to installation requirement

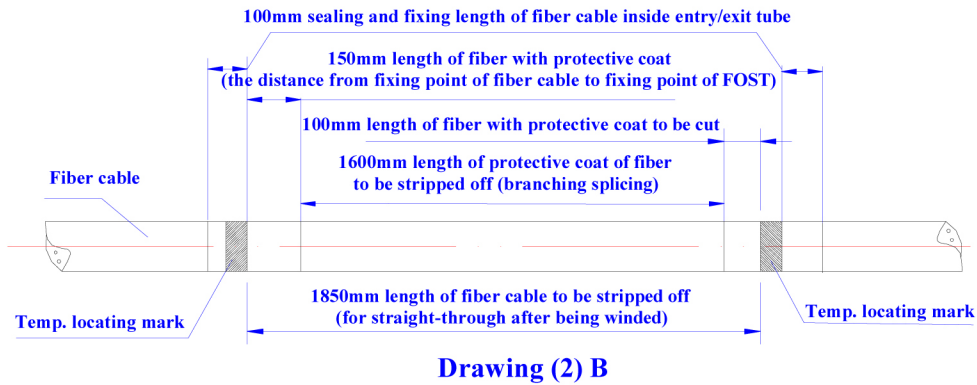
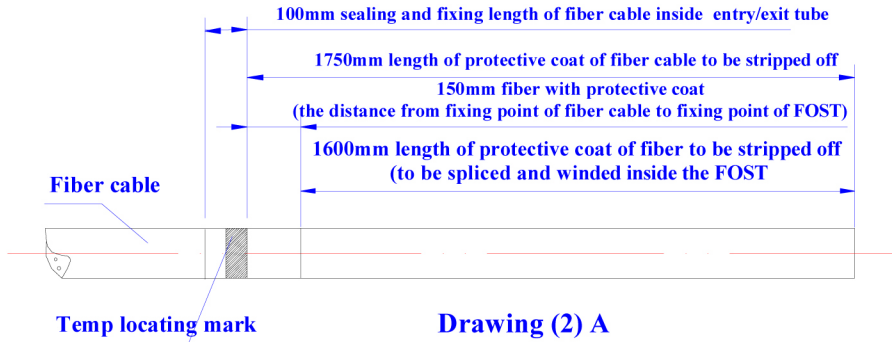

### 5.3 Step Three –Strip off protective coat of fiber cable and fiber

5.3.1 Strip off protective coat of fiber cable from the temp. locating mark with the cutter and the stripper, please refer to Drawing 2 for stripping length. Stripping length also could be decided according to installation requirement

5.3.2 See Drawing 3.

**Important issues:** If it is difficult to pull all the protective coat of fiber cable at one time, strip it off section by section to avoid fiber breakage.

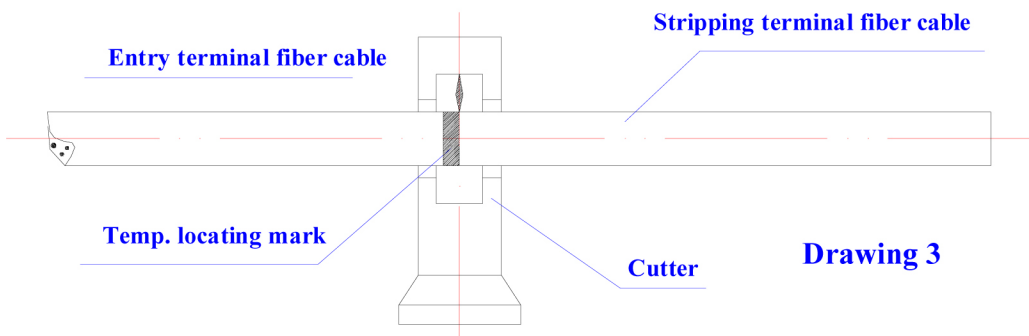

### 5.4 Step Four – Separate fiber cores and prepare work prior to fixing fiber cable.

5.4.1 Wind 2 layers of insulation tape on protective coat of fiber core for protection.

Meanwhile, get rid of the stuffing to separate fiber core and clean them. Form a ring with the diameter of 100mm or so and fix it on the fiber temporarily by adhesive tape.

5.4.2 Depending on fiber cable stripped, the following two cases are available.

- ① All fibers are to be branched after being spliced completely.
- ② Some of fibers are for straight-through after being winded, while the others are for branch splicing.

- 5.4.3 The FOSC is provided with 3 single entry/exit tubes which suit for single fiber cables with max. diameter  $\phi 16\text{mm}$  and 1 mass entry/exit tube which suits for 1 piece of fiber cable with max. diameter  $\phi 25\text{mm}$  or 2 pieces of fiber cables with max. diameter  $\phi 21\text{mm}$  or multi-pieces of fiber cables with short diameter.
- 5.4.4 Mass entry/exit tube is required if some fibers are for straight-through
- 5.4.5 The corresponding entry/exit tube cover could be slightly knocked out with screwdriver from inside to outside according to number and diameter of fiber cable required.
- 5.4.6 Reserve reinforced core in 70mm length and cut off the unnecessary ones.
- 5.4.7 See Drawing 4 and Drawing 5.

**Important Issues:** Entry/exit tubes are to be selected accurately to make it easy for splicing and sealing.

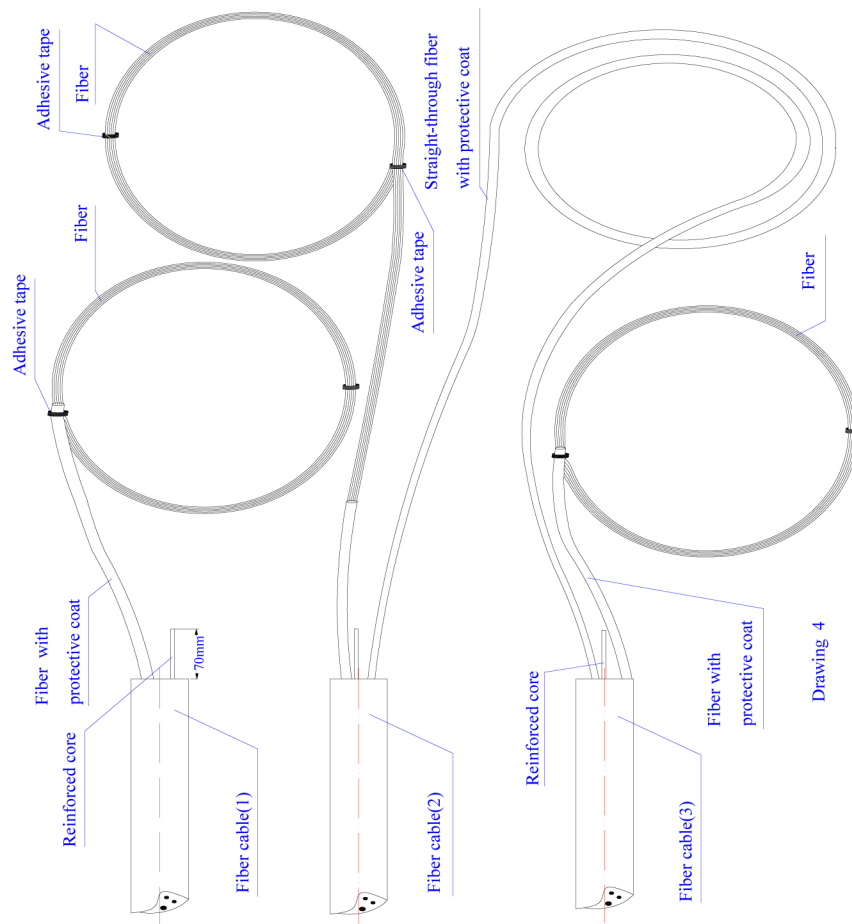

## 5.5 Fix reinforced core, and pyrocondense, fix and seal fiber cable.

- 5.5.1 Insert fiber cable into the corresponding heat shrinkable fixing tube, further insert the them into entry/exit tube at the bottom of FOSC.



- 5.5.2 Demount fixing nut of reinforced core with a special wrench (plastic one), which is to be inserted into the fixing slot afterward and tighten it. Then retighten it with a metal wrench (the metal wrench is to be provided by operator).
- 5.5.3 Hitch heat shrinkable fixing sleeve to the fiber cable till its root by hand.
- 5.5.4 Please refer to Drawing 5 for installing branching clip.
- 5.5.5 Heat heat shrinkable fixing sleeve with fire sprayer to make it hugging entry/exit tube and fiber cable to reach complete sealing.
- 5.5.6 See Drawing 5

**important issue:** 1. Fixing nut of reinforced core should be tightened.

- 2. While heating, heat shrinkable fixing tube should shrink evenly, and there should be no bubbles, pores and other defects inside the tube.

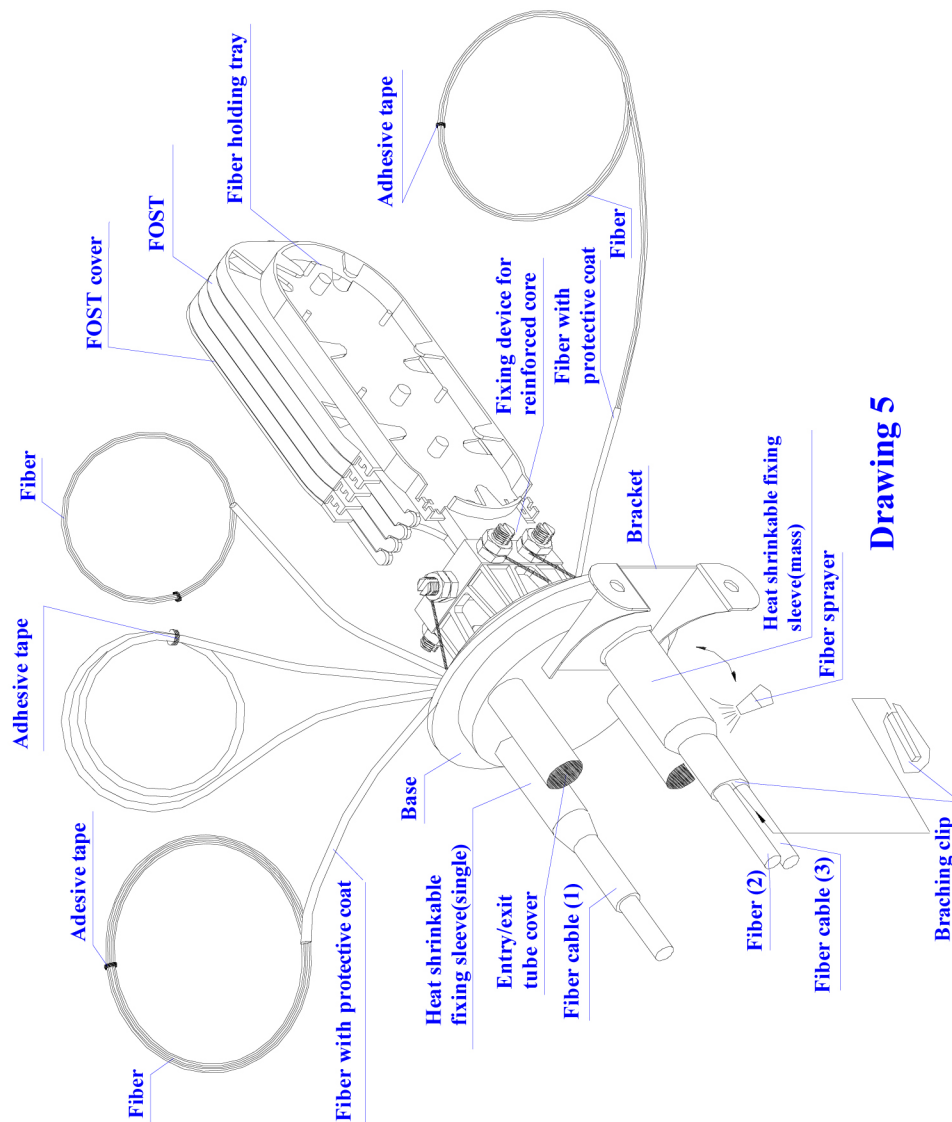

## 5.6 Step Six - Splice fibers

5.6.1 Follow user manual of fusion splicing machine to splice fiber.

**Important issue:** pay attention to the twist and bend of fiber

## 5.7 Step Seven -Install heat shrinkable protective sleeve and house fibers.

5.7.1 When having completed splicing the fibers, the first fiber ring should be housed on the farthest side of FOST, the remaining fiber optic should be wound, forming a ring with diameter not less than 80mm. then put it into FOST (Fiber Optic Splice Tray) together with heat shrinkable protective sleeve.

( Firstly fix heat shrinkable protective sleeve into the slot, then enlarge the diameter of fiber ring properly.)

5.7.2 see Drawing 6

**Important issue:** pay attention to the twist and bend of fiber.

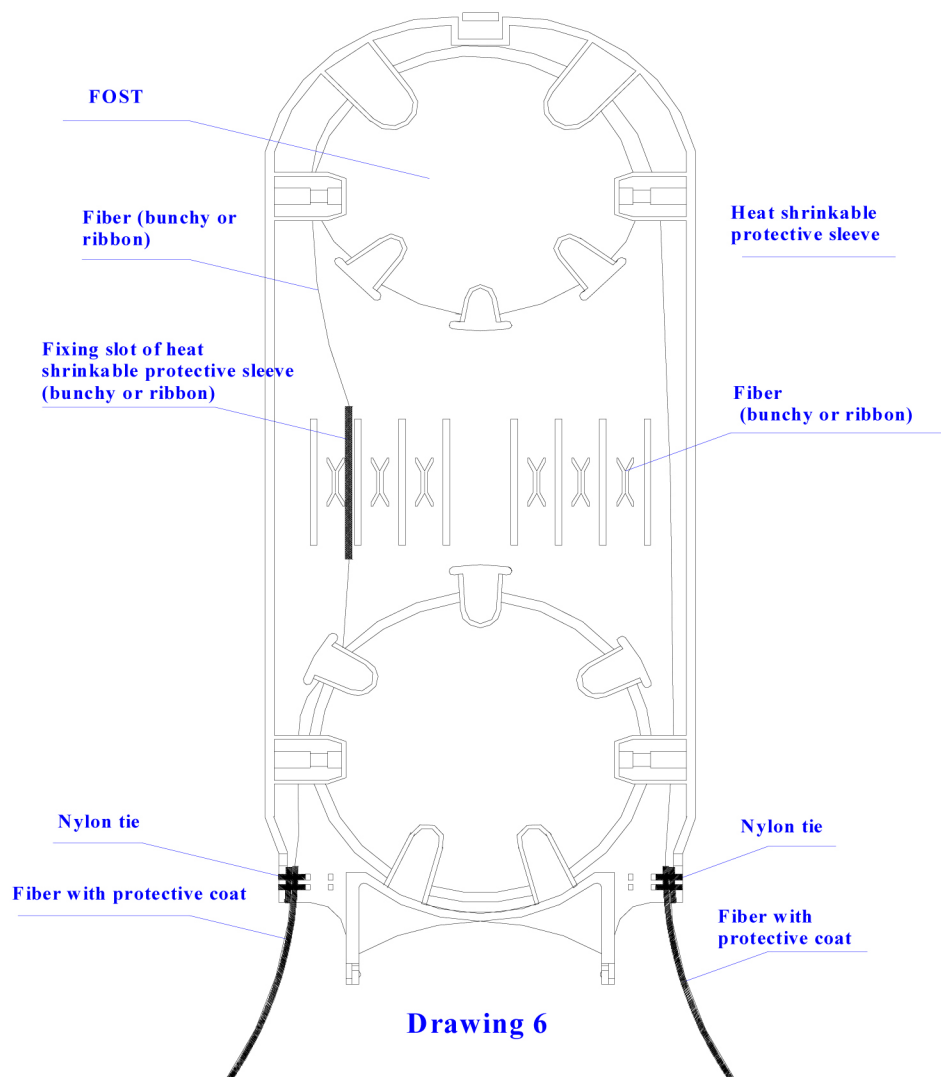

## 5.8 Step Eight - Check up comprehensively

To ensure the technical requirements, the following instructions must be followed:

- 5.8.1 Fibers with protective coat are fixed with nylon tie at the entrance of FOST.
- 5.8.2 Grommet should be pressed from inside to outside in order to properly install FOST.
- 5.8.3 Straight-through and reserved fibers with protective coat should be wound to the fiber holding tray.
- 5.8.4 Check whether the internal tighteners and fixing nut of reinforced core are well tightened.
- 5.8.5 Check whether seal fitting is installed neatly and smoothly.
- 5.8.6 Check whether heat shrinkable fixing sleeve is reliable and sealing completely.
- 5.8.7 See Drawing 7.

**Important issues:** If any problems occur, they should be solved right away.

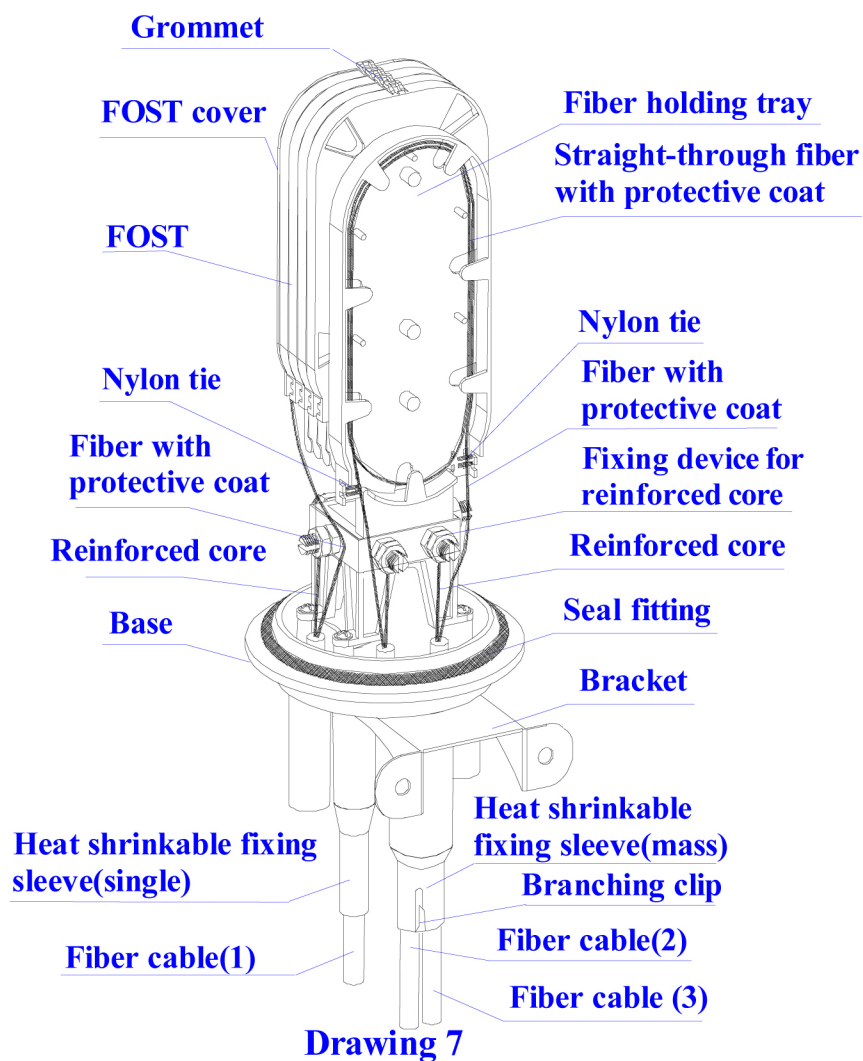

## 5.9 Step Nine – Assemble FOSC housing and fix FOSC

- 5.9.1 Put desiccant into FOSC.
- 5.9.2 Put FOSC cover on base directly.
- 5.9.3 Install plastic hoop between FOSC cover and base, tighten hoop locking system, which is to be fixed by hoop fixing bolt then.
- 5.9.4 FOSC installation
  - ① Aerial application: fix metal hoop and transom to the pole. Please refer to Drawing 8
  - ② Wall mounting application: fix the bracket on the wall with bolt. (metal hoop is not required.)
  - ③ Underground application: metal hoop is not required.
- 5.9.5 See drawing 8

**Important issues:** 1. Pay attention while installing plastic hoop.  
2. The specification of bolt for fixing the bracket is M8.

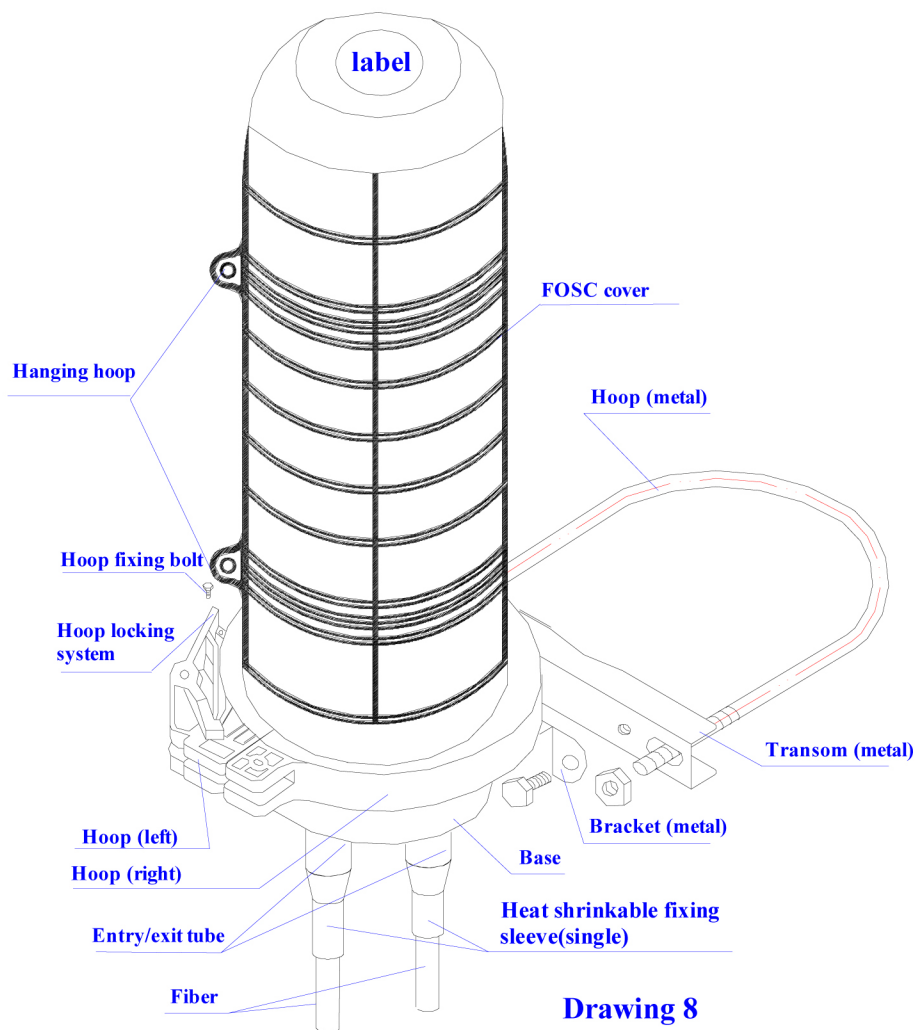

## 6. Fiber Optic Splice Closures (FOSC) inspecting and testing items

Inspecting item	Technical Requirements	Inspecting type	
		Routine test (Before leaving factory)	Type test
<b>Package</b>	Each small package contains one fiber optic splice closure, together with its accessories, tools, installation manual and packing list.	full	At least 3 sets sampled each time
<b>Appearance</b>	Intact in shape, no burrs, bubbles, chaps, pores, warps, impurities and other defects, all background colors should be even and continual.		
<b>Sign</b>	There is a clear sign on the housing, such as name and model of the product, etc.		
<b>Fiber storage device</b>	The fibers reserved are to be winded in fiber optic splice tray (FOST), the length of fibers housed in FOST is >1.6m, the curved radius is >30mm. During the installation and maintenance, there should be no attenuation on fibers.	At least 3 sets sampled each time	
<b>Electrical jointing device</b>	Inside FOCS: metallic components of fiber cables has the functions of electrical putting through, earthing connection and disconnecting. It is possible to install earthing deriving device outside the housing		
<b>Sealing performance</b>	After sealing according to the stipulated operation procedures, the injected air pressure is 100KPa±5Kpa, when immersed in clean water of normal temperature for 15 minutes, there should be no air bubbles, then observed for 24 hours, there should be no change of air pressure.		
<b>Re-sealing performance</b>	After reopening and resealing according to the stipulated operation procedures, the injected air pressure is 100KPa ± 5Kpa, when immersed in clean water of normal temperature for 15 minutes, there should be no air bubbles, then observed for 24 hours, there should be no change of air pressure.		
<b>Pull</b>	Bearing pull is $\cong$ 800N at axle orientation, there should be no breakage on the housing.		
<b>Punching</b>	Bearing pressure of 2000N/10cm for 1 minutes, there should be no breakage on the housing		
<b>Impact</b>	Bearing impact energy of 16N•m, 3 times of impacts there should be not breakage on the housing		

<b>Bending</b>	The spot between the FOSC and seal fitting can bear bending tension of 150N at bending angle of $\pm 45^{\circ}$ for 10 circles, there should be no breakage on the housing		
<b>Torsion</b>	Bearing torsion $50\text{N}\cdot\text{m}$ , 10 circle at torsion angle $\pm 90^{\circ}$ . There should be no breakage on the housing.		
<b>Temperature circle</b>	Injected air pressure of $60\text{KPa} \pm 5\text{KPa}$ , the temperature circle ranging from $-40^{\circ}\text{C} \sim +65^{\circ}\text{C}$ , 10 times of the circular tests (one circular consists of high temperature for 2 hours + indoor temperature for 2 hours + low temperature for 2 hours + indoor temperature for 2 hours ) when the pressure declines, the amplitude is $\leq 5\text{Kpa}$ , immerse the swatch in clean water of normal temperature for 15 minutes, there should be no air bubbles.		
<b>Voltage resistance strength</b>	After sealing the FOSC according to the stipulated operation procedures, immerse it in clean water of normal temperature in 1.5m depth for 24 hours, there should be no breakdown or arc over between the metallic components of the FOSC, between metallic components and the ground at DC 15KV for 1 minutes.		
<b>Isolating resistance</b>	After sealing the FOSC according to stipulated operation procedure, immerse it in clean water in 1.5m depth for 24h, the isolating resistance between the metallic components of the FOSC, between the metallic components and the ground should be $\geq 2 \times 10^4 \text{M}\Omega$ .		